

PCR-T275

Electronic Cash Register



(U. S. model)



(Canada model)

User's Manual

START-UP is QUICK and EASY!
Simple to use!
15 departments and 100 PLUs
Automatic Tax Calculations
Calculator function

CASIO COMPUTER CO., LTD.
6-2, Hon-machi 1-chome
Shibuya-ku, Tokyo 151-8543, Japan

CASIO® 

Thank you very much for purchasing this CASIO electronic cash register.
START-UP is QUICK and EASY!

Part-1 of this User's Manual can help you make a quick start.

Once you have mastered the QUICK START operations, you will undoubtedly want to expand your use of this machine by studying other sections of Part-2.

IMPORTANT

**FOR PROGRAMMING ASSISTANCE
PLEASE CALL TOLL FREE**

1-800-638-9228

CASIO authorized service centers

If your CASIO product needs repair, or you wish to purchase replacement parts, please call 1-800-YO-CASIO.

Original carton / package

If for any reason, this product is to be returned to the store where purchased, it must be packed in the original carton/package.

Location

Locate the cash register on a flat, stable surface, away from heaters or areas exposed to direct sunlight, humidity or dust.

Power supply

Your cash register is designed to operate on standard household current (120 V, 50/60 Hz). Do not overload the outlet by plugging in too many appliances.

Cleaning

Clean the cash register exterior with a soft cloth which has been moistened with a solution of a mild neutral detergent and water, and wrung out.

Be sure that the cloth is thoroughly wrung out to avoid damage to the printer.

Never use paint thinner, benzene, or other volatile solvents.

Safety precautions

- To use this product safely and correctly, read this manual thoroughly and operate as instructed. After reading this guide, keep it close at hand for easy reference. Please keep all informations for future reference.
- Always observe the warnings and cautions indicated on the product.

About the icons

In this guide various icons are used to highlight safe operation of this product and to prevent injury to the operator and other personnel and also to prevent damage to property and this product. The icons and definitions are given below.



Indicates that there is a risk of severe injury or death if used incorrectly.



Indicates that injury or damage may result if used incorrectly.

Icon examples

To bring attention to risks and possible damage, the following types of icons are used.



The \triangle symbol indicates that it includes some symbol for attracting attention (including warning). In this triangle the actual type of precautions to be taken (electric shock, in this case) is indicated.



The \otimes symbol indicates a prohibited action. In this symbol the actual type of prohibited actions (disassembly, in this case) will be indicated.



The \bullet symbol indicates a restriction. In this symbol the type of actual restriction (removal of the power plug from an outlet, in this case) is indicated.

Warning!

Handling the register



Should the register malfunction, start to emit smoke or a strange odor, or otherwise behave abnormally, immediately shut down the power and unplug the AC plug from the power outlet. Continued use creates the danger of fire and electric shock.

- Contact CASIO service representative.



Do not place containers of liquids near the register and do not allow any foreign matter to get into it. Should water or other foreign matter get into the register, immediately shut down the power and unplug the AC plug from the power outlet. Continued use creates the danger of short circuit, fire and electric shock.

- Contact CASIO service representative.



Should you drop the register and damage it, immediately shut down the power and unplug the AC plug from the power outlet. Continued use creates the danger of short circuit, fire and electric shock.

- Attempting to repair the register yourself is extremely dangerous. Contact CASIO service representative.

⚠ Warning!



Never try to take the register apart or modify it in any way. High-voltage components inside the register create the danger of fire and electric shock.

- Contact CASIO service representative for all repair and maintenance.

Power plug and AC outlet



Use only a proper AC electric outlet. Use of an outlet with a different voltage from the rating creates the danger of malfunction, fire, and electric shock. Overloading an electric outlet creates the danger of overheating and fire.



Make sure the power plug is inserted as far as it will go. Loose plugs create the danger of electric shock, overheating, and fire.

- Do not use the register if the plug is damaged. Never connect to a power outlet that is loose.



Use a dry cloth to periodically wipe off any dust built up on the prongs of the plug. Humidity can cause poor insulation and create the danger of electric shock and fire if dust stays on the prongs.



Do not allow the power cord or plug to become damaged, and never try to modify them in any way. Continued use of a damaged power cord can cause deterioration of the insulation, exposure of internal wiring, and short circuit, which creates the danger of electric shock and fire.

- Contact CASIO service representative whenever the power cord or plug requires repair or maintenance.

⚠ Caution!



Do not place the register on an unstable or uneven surface. Doing so can cause the register — especially when the drawer is open — to fall, creating the danger of malfunction, fire, and electric shock.



Do not place the register in the following areas.

- Areas where the register will be subject to large amounts of humidity or dust, or directly exposed to hot or cold air.
- Areas exposed to direct sunlight, in a close motor vehicle, or any other area subject to very high temperatures.

The above conditions can cause malfunction, which creates the danger of fire.



Do not overlay bend the power cord, do not allow it to be caught between desks or other furniture, and never place heavy objects on top of the power cord. Doing so can cause short circuit or breaking of the power cord, creating the danger of fire and electric shock.



Be sure to grasp the plug when unplugging the power cord from the wall outlet. Pulling on the cord can damage it, break the wiring, or cause short, creating the danger of fire and electric shock.



Never touch the plug while your hands are wet. Doing so creates the danger of electric shock. Pulling on the cord can damage it, break the wiring, or cause short, creating the danger of fire and electric shock.

Never touch the printer head and the platen.

Contents

Getting to know your cash register	6
Daily Job Flow	8
Part-1 QUICK START OPERATION	9
(You can operate this ECR on a basic level by reading the following sections)	
1. Initialization	9
2. To select the language	9
3. Loading paper	10
4. Basic programming for QUICK START – TIME/DATE	11
5. Basic operation after basic programming	13
6. Daily management report	16
Part-2 CONVENIENT OPERATION	17
(Please keep these sections to expand your use.)	
1. Various programming	17
2. Various operations	29
Part-3 CALCULATOR FUNCTION	36
1. Calculator mode	36
Part-4 USEFUL INFORMATION	38
1. Troubleshooting	38
2. Specifications	39
3. Warranty card	39

Before you start

Unpacking

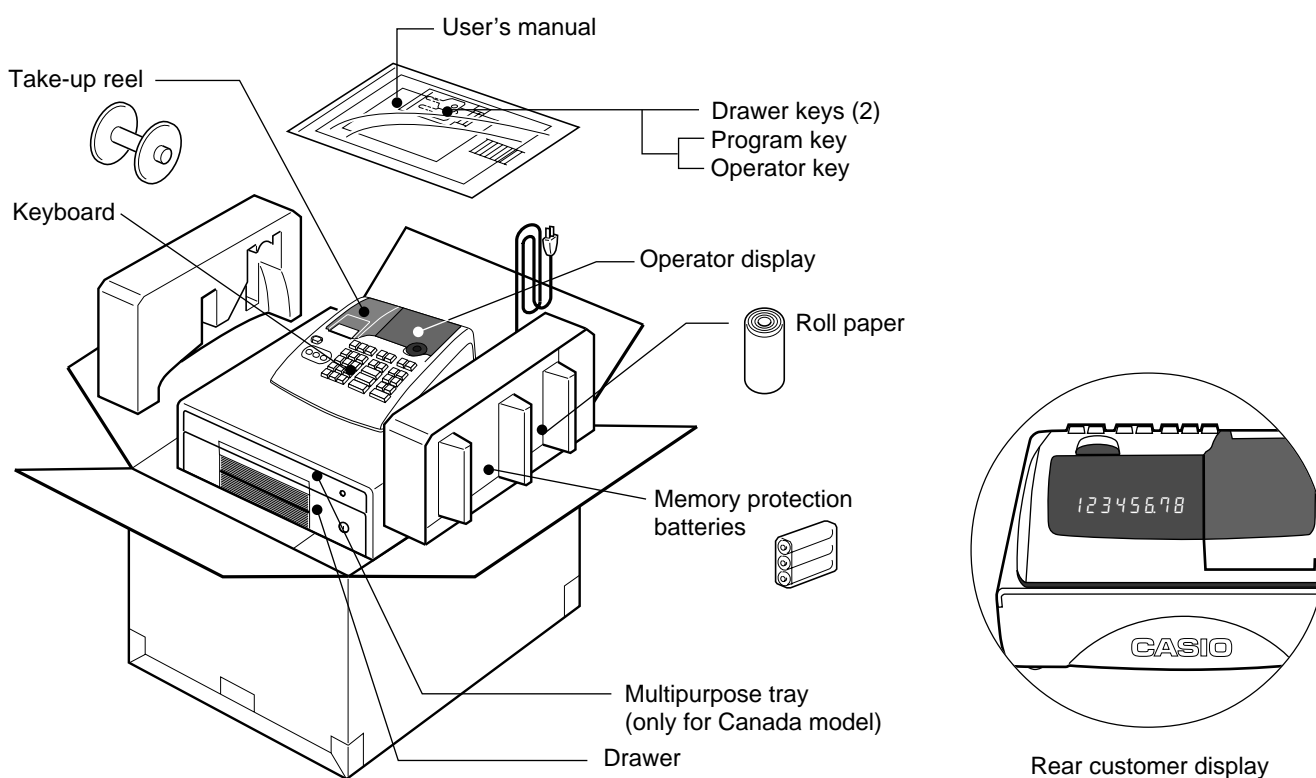

Getting to know your cash register

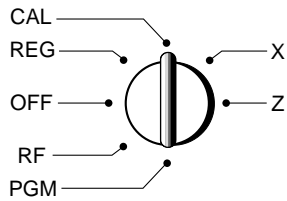

The position of the mode switch controls the type of operations you can perform on the cash register. The PROGRAM Key (marked PGM) that comes with the cash register can be used to select any mode switch setting, while the OPERATOR Key (marked OP) can be used to select OFF, REG or CAL only.

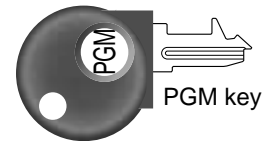
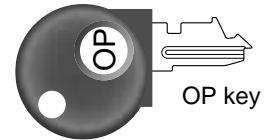
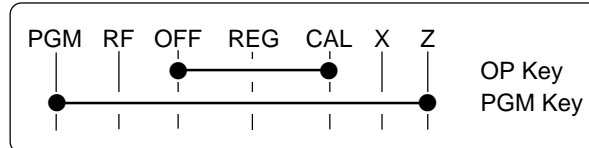

Note:

An error is generated (E01 displayed) whenever the position of the mode switch is changed during registration or programming.

OFF

In this position, the power of the cash register is off.

REG (Register)

This is the position used for registration of normal transactions.

RF (Refund)

This is the position used for registration of refunds.

CAL (Calculator)

This is the position used for calculator mode.

PGM (Programming)

This is the position used to program the cash register to suit the needs of your store.

X (Read)

This is the position used to produce reports of daily sales totals without clearing the totals.

Z (Reset)

This is the position used to produce reports of daily sales totals. This setting clears the totals.

Displays

Operator display

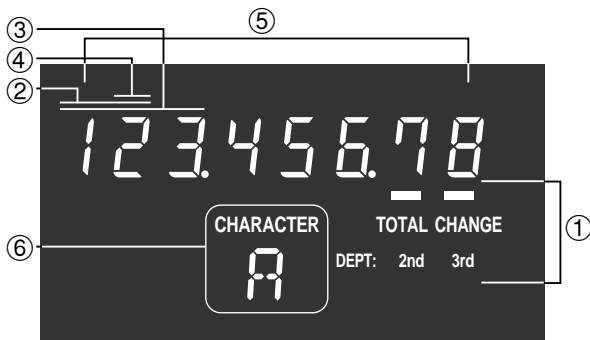

Rear customer display



① **Total/Change indicator**

The total or change indicator appears when a subtotal, total or change is obtained. These indicators are also used for department shift level.

② **Department number display**

Anytime you press a department key to register a unit price, the corresponding department number appears here.

③ **PLU number display**

Anytime you perform a PLU registration, the corresponding PLU number appears here.

④ **Number of repeat display**

Anytime you perform "repeat registration" (page 13), the number of repeats appears here.

Note that only one digit is displayed for the number of repeats.

⑤ **Numeric display**

Entered values (unit prices or quantities) and calculated values (subtotals, totals or change amount due) are displayed here. The capacity of the display is 8 digits.

This part of the display can be used to show the current time or date between registration (page 33).

⑥ **Character display**

In the character programming (P2) mode, it shows the last entered character.

Keyboard

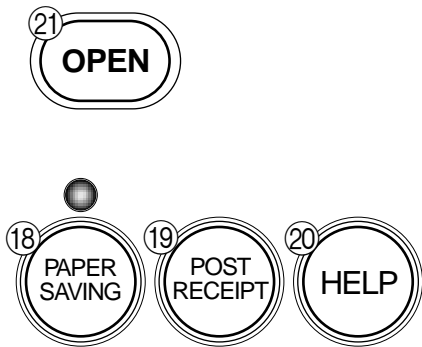

Certain keys have two functions; one for register mode and one for calculator mode.

In this manual, we will refer to specific keys as noted below to make the operations as easy to understand as possible:

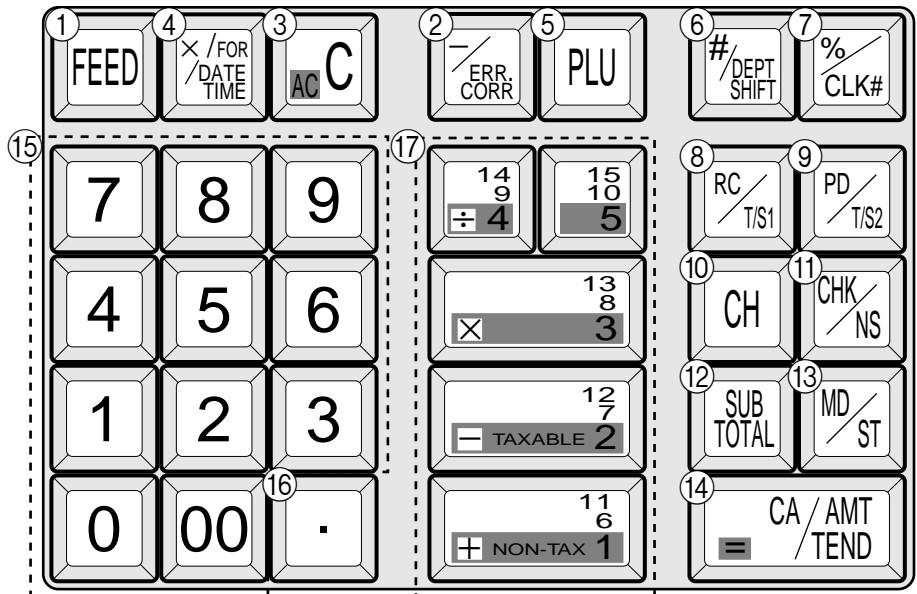

Register mode

- ① **FEED** Feed key
- ② **ERR CORR** Minus/Error correction key
- ③ **AC C** Clear key
- ④ **X / FOR DATE TIME** Multiplication/for/Date time key
- ⑤ **PLU** PLU (price look up) key
- ⑥ **#/DEPT SHIFT** Reference number/Department shift key
- ⑦ **%/CLK#** Percent/Clerk number key
- ⑧ **RC / T/S1** Received on account/Tax shift 1 key
- ⑨ **PD / T/S2** Payout/Tax shift 2 key
- ⑩ **CH** Charge key
- ⑪ **CHK / NS** Check/No sale key
- ⑫ **SUB TOTAL** Subtotal key
- ⑬ **MD / ST** Merchandise subtotal key
- ⑭ **CA / AMT TEND** Cash amount tendered key
- ⑮ **0, 1, ~ 9, 00** Numeric keys and 2-zero key
- ⑯ **.** Decimal key
- ⑰ **+¹¹/₉, -¹²/₂, ×¹³/₃, ÷¹⁴/₄, ¹⁵/₅** Department keys

- Department 6 through 15 are specified by pressing the **#/DEPT SHIFT** key (once or twice) respectively as follows:
#/DEPT SHIFT **+¹/₁** → Department 6 **#/DEPT SHIFT** **-²/₂** → Department 7...
#/DEPT SHIFT **¹⁰/₅** → Department 10 ... **#/DEPT SHIFT** **#/DEPT SHIFT** **+¹/₁** → Department 11
 ... **#/DEPT SHIFT** **#/DEPT SHIFT** **¹⁵/₅** → Department 15

- ⑱ **●** Paper saving key

- Paper saving key is the key to save printing paper (Journal compressed printing / No receipt issuing). In these cases, the LED of this key lights.

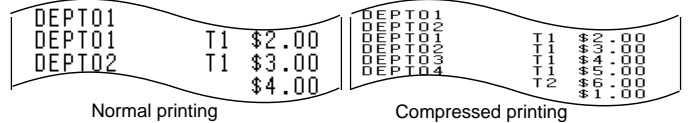

- ⑲ **●** Post receipt key

- Post receipt key is used for issuing receipt after transaction. This key is effective if the printer is defined as printing receipts. Refer to page 31.

- ⑳ **●** Help key

- Help key is used for issuing assistant receipts such as programming date/time, tax table etc.

- ㉑ **OPEN** Printer open key

- Printer open key is used to open printer platen for setting/replacing roll paper.

Calculator mode

- ③ **AC c** AC key
- ⑤ **PLU** Memory recall key
- ⑦ **%/CLK#** Percent key
- ⑮ **0, 1, ~ 9, 00** Numeric keys and 2-zero key
- ⑯ **.** Decimal key
- ⑰ **+¹¹/₉, -¹²/₂, ×¹³/₃, ÷¹⁴/₄** Arithmetic operation key
- ⑭ **CA / AMT TEND** Equal key
- ⑪ **CHK / NS** Drawer open key

Daily Job Flow

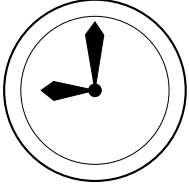

Before opening the store

1. Plugged in?
2. Enough roll paper?
3. Date and time is correct?
4. Enough small change in the drawer?

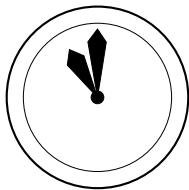
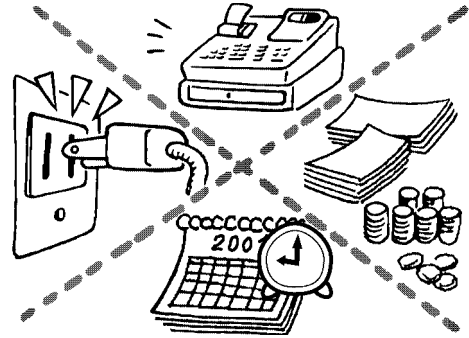

While the store is open

1. Registrations.
2. Issuing latest daily sales total if needed.
(Generating report by mode switch to X position.)

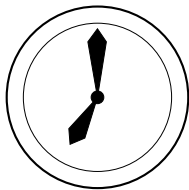

After closing the store

1. Issuing daily sales total.
(Resetting report by mode switch to Z position.)
2. Picking up money in the drawer.
3. Turn the mode switch to OFF.

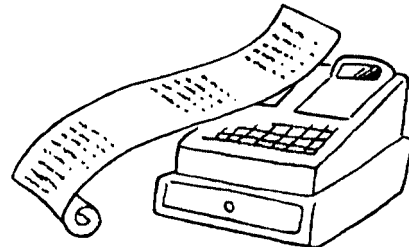

To lock/unlock the multipurpose tray

(only for Canada model)

- A. Turn the lever (1) clockwise to lock the tray (the indicator becomes red).
- B. Turn the lever (1) counterclockwise to unlock the tray (the indicator becomes green).

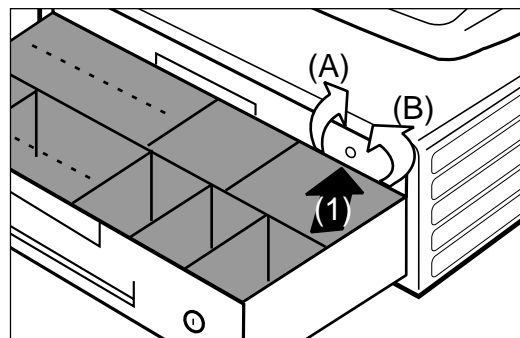

1. Initialization and loading memory protection battery

Important

You must initialize the cash register and install the memory protection batteries before you can program the cash register.

► To initialize the cash register

1. Set the mode switch to OFF.
2. Plug the power cord of the cash register into an AC outlet.
3. Load the memory protection batteries.
4. Set the Mode Switch to REG.

► To load the memory protection batteries

1. Open the platen arm.
2. Press down on the oval just behind the printer paper inlet, and slide the battery compartment cover toward the back of the cash register.
3. Load 3 new SUM-3 ("AA") type batteries into the compartment. Be sure that the plus (+) and minus (-) ends of each battery are facing in the directions indicated by the illustrations inside the battery compartment (Figure 1).
4. Slide the memory protection battery compartment cover back into place.
5. Replace the printer paper and printer cover.



(Figure 1)

REPLACE MEMORY PROTECTION BATTERIES AT LEAST ONCE EVERY YEAR.

2. To select the language

You can select the default printing language depending on the requirements in your area.
Default language is English.

Example:

Change the language to Spanish.

1. Set the mode switch to PGM.
2. Press the following keys.

2
9
9
9

 Select numbers from list A.

Language selections				
English	1	9	9	9
Spanish	2	9	9	9
French	3	9	9	9

A

3. Loading paper roll

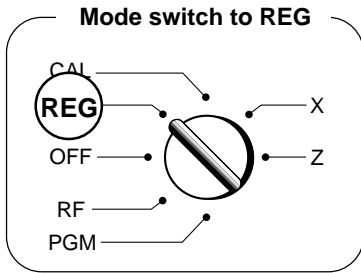

1. To load journal paper

- ① Pressing down the printer open key.



- ② Open the platen arm.



- ③ Ensuring the paper is being fed from the bottom of the roll, lower the roll into the space behind the printer.



- ④ Put the leading end of the paper over the printer.



- ⑤ Close the platen arm slowly until it locks steadily.



- ⑥ Remove the printer cover by lifting up the back.

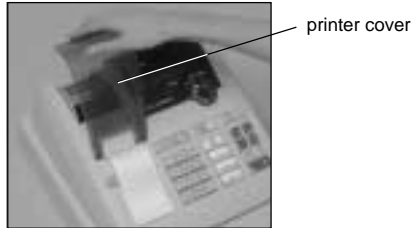

- ⑦ Roll the paper onto the take-up reel a few turns.

- ⑧ Set the left plate of the take-up reel and place the reel into the register.



- ⑨ Press the **FEED** key to take up any slack in the paper.

- ⑩ Replace the printer cover slowly.



2. To remove journal paper

- ① Remove the printer cover by lifting up the back.



- ② Press the **FEED** key until approximately 20cm of the paper is fed from the printer.

- ③ Cut off the roll paper.



- ④ Remove the take-up reel from the printer and take off the left plate of the reel.

- ⑤ Remove the journal paper from the take-up reel.



- ⑥ Press the printer open key and open the platen arm.



- ⑦ Remove the core of the paper.



- ⑧ Load new paper following the instructions "1. To load journal paper".

Default printer definition is journal printer. To print receipts, please refer to the "Basic programming for QUICK START" on the next page.

▶ To load receipt paper

- ① In case of defining the printer as receipt printer, follow steps 1 through 5 of "To load journal paper".

- ② Pass the leading end of the receipt paper through the paper outlet of the printer cover.

- ③ Tear off any excess paper.

▶ To remove receipt paper

- ① In case of defining the printer as journal printer, follow steps 6 through 7 of "To remove a journal paper".

▶ Caution (in handling the thermal paper)

1. Never touch the printer head and platen.
2. Unpack the paper just before your use.
3. Avoid heat/direct sunlight.
4. Avoid dusty and humid places for storage.
5. Do not scratch the paper.
6. Do not keep the paper under the following circumstances: High humidity and temperature/direct sunlight/contact with glue, thinner or a rubber eraser.

4. Basic programming for QUICK START

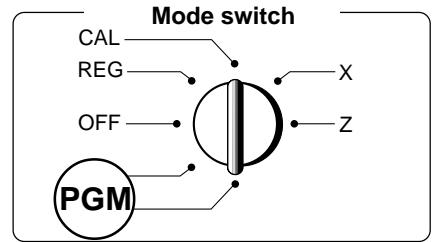

Part-1

Procedure	Purpose
1. Insert the PROGRAM key (marked "PGM") and rotate to PGM position.	Programming
2. Press the following keys to set the current time. Example: 13:18 PM = 1318 <div style="display: flex; justify-content: center; align-items: center; gap: 10px;"> <div style="text-align: center;"> 1 3 1 8 </div> <div style="text-align: center;"> SUB TOTAL </div> <div style="text-align: center;"> X / FOR DATE TIME </div> <div style="text-align: center;"> AC C </div> </div> <p style="text-align: center;">Time Minutes</p> <ul style="list-style-type: none"> • Enter 4 digits • 24-hour time format 	P appears in mode display (to end the time setting) Setting the current time
3. Press the following keys to set the current date. Example: July 19, 2003 = 030719 <div style="display: flex; justify-content: center; align-items: center; gap: 10px;"> <div style="text-align: center;"> 0 3 0 7 1 9 </div> <div style="text-align: center;"> SUB TOTAL </div> <div style="text-align: center;"> X / FOR DATE TIME </div> <div style="text-align: center;"> AC C </div> </div> <p style="text-align: center;">Year Month Date</p> <ul style="list-style-type: none"> • Enter 6 digits • Enter last 2 digits for year set. (2003 → 03) 	P appears in mode display (to end the date setting) Setting the current date
4. Press the following keys to define the printer as a receipt printer or a journal printer. To define as a receipt printer <div style="display: flex; justify-content: center; align-items: center; gap: 10px;"> <div style="text-align: center;"> 1 SUB TOTAL </div> <div style="text-align: center;"> 1 CH </div> <div style="text-align: center;"> SUB TOTAL </div> </div> <p style="text-align: center;">P appears in mode display. Enter "1" for receipt.</p> To define as a journal printer <div style="display: flex; justify-content: center; align-items: center; gap: 10px;"> <div style="text-align: center;"> 1 SUB TOTAL </div> <div style="text-align: center;"> 0 CH </div> <div style="text-align: center;"> SUB TOTAL </div> </div> <p style="text-align: center;">P appears in mode display. Enter "0" for journal.</p>	Setting the printer attribution

FOR PROGRAMMING ASSISTANCE, PLEASE CALL TOLL FREE 1-800-638-9228

Procedure	Purpose
<p>5. Follow the following steps.</p> <p>5-1. Issue "Help directory report".</p> <p style="text-align: center;">●</p> <p>The following report is issued.</p> <div style="border: 1px solid black; padding: 5px; width: fit-content; margin: 10px auto;"> <pre> ENTER NUMBER THEN PRESS <HELP> KEY. 01.HOW TO PROGRAM DATE AND TIME? 02.HOW TO PROGRAM TAX TABLE? : 09.LANGUAGE CHANGE </pre> </div> <p>Select 02 (Tax table programming). →</p> <p>5-2. Issue "Tax table index report".</p> <p style="text-align: center;">2 ●</p> <p>The following report is issued.</p> <div style="border: 1px solid black; padding: 5px; width: fit-content; margin: 10px auto;"> <pre> 02.HOW TO PROGRAM TAX TABLE? -SELECT YOUR STATE AND ENTER NUMBER THEN PRESS <HELP> KEY. 0101:ALABAMA 0201:ALASKA 0301:ARIZONA : 5001:WISCONSIN 5101:WYOMING </pre> </div> <p>Select your state. →</p> <p>5-3. Issue "State tax table code report".</p> <p style="text-align: center;">0 1 0 1 ●</p> <p>The following report is issued.</p> <div style="border: 1px solid black; padding: 5px; width: fit-content; margin: 10px auto;"> <pre> PLEASE SELECT YOUR DISTRICT NUMBER FROM BELOW TABLE. 1)TURN MODE KEY TO PGM. 2)3<SUBTOTAL> 3)025<SUBTOTAL> SET TABLE1 4)XXXX <CASH>KEY. SET TABLE2(IF NECESSARY) 5)XXXX <CASH>KEY. 6)<SUBTOTAL> XXXX IS DISTRICT NUMBER ALABAMA 0101: 4% State 0102: 4.5% State & Local 0103: 5% State & Local : 0111: 9% State & Local </pre> </div> <p>Follow these steps. →</p>	<p>Setting the tax table.</p>

5. Basic operation after basic programming

Note:

Whenever an error is generated (E01 displayed), the input figures reset to 0. All printout samples are receipt images and the header (date, time and consecutive no.) are eliminated from the samples.

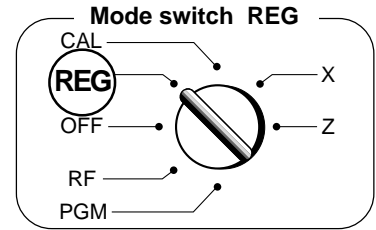

Part-1



5-1 Open the drawer without a sale

CHK / NS

NS No sales symbol

5-2 Basic operation

Example

Unit Price	\$1.00	\$2.00
Quantity	1	1
Dept.	2	10
Cash Amount tendered	\$5.00	

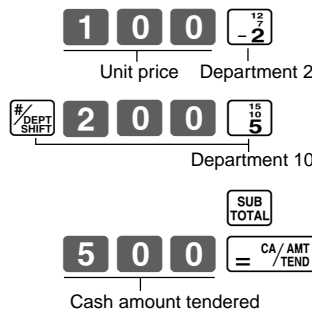

TAXABLE	T1	\$1.00	Department name/Unit price
DEPT10		\$2.00	
TAX-AMT1		\$1.00	Taxable amount
TAX1		\$0.04	Tax amount
TOTAL		\$3.04	Subtotal
CASH		\$5.00	Cash amount tendered
CHANGE		\$1.96	Change amount due

Departments 6 through 10 and 11 through 15 can also be registered in combination with the $\left[\frac{\#}{\text{DEPT SHIFT}} \right]$ and $\left[\frac{1}{+1} \right]$, $\left[\frac{2}{-2} \right]$, $\left[\frac{3}{\times 3} \right]$, $\left[\frac{4}{\div 4} \right]$ or $\left[\frac{15}{5} \right]$ keys, respectively. The $\left[\frac{\#}{\text{DEPT SHIFT}} \right]$ key should be entered once for department 6 ~ 10, twice for department 11 ~ 15 just before entering unit price manually.

5-3 Multiple registration on the same items

Example

Unit Price	\$1.00	\$1.35
Quantity	2	3
Dept.	2	2

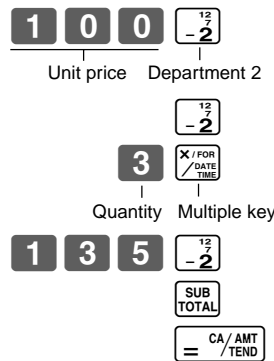

TAXABLE	T1	\$1.00	Repeat
TAXABLE	T1	\$1.00	
TAXABLE	3 X	@1.35	Quantity/Unit price
TAXABLE	T1	\$4.05	
TAX-AMT1		\$6.05	
TAX1		\$0.24	
CASH		\$6.29	

Note that repeated registration can be used with unit prices up to 6 digits long.

5-4 Split sales of packaged items

Example

Unit price	12/\$10.00
Quantity	3
Dept.	1

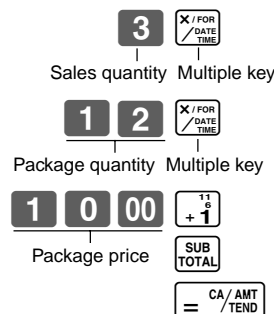

NON-TAX	3 X @10.00 / 12	Package price/quantity
CASH	\$2.50	

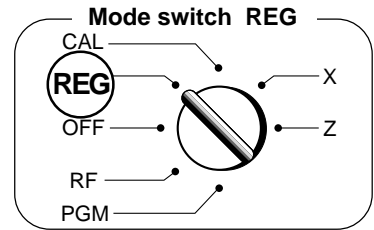

5-5 Charge sales

Example

Unit Price	\$1.00	\$2.00	\$3.00
Quantity	1	1	1
Dept.	1	2	1

Operation

1 0 0 $\overset{11}{\underset{9}{+1}}$
 2 0 0 $\overset{12}{\underset{7}{-2}}$
 3 0 0 $\overset{11}{\underset{9}{+1}}$
 SUB TOTAL
 CH

Charge key

Printout

NON-TAX		\$1.00	
TAXABLE	T1	\$2.00	
NON-TAX		\$3.00	
TAX-AMT1		\$2.00	
TAX1		\$0.08	
CHARGE		\$6.08	Charge sales

You cannot perform the amount tendered operation using the **CH** key.

5-6 Split cash/charge sales

Example

Unit Price	\$2.00	\$3.00	\$4.00
Quantity	1	1	1
Dept.	1	2	1
Cash Amount tendered	\$5.00		

2 0 0 $\overset{11}{\underset{9}{+1}}$
 3 0 0 $\overset{12}{\underset{7}{-2}}$
 4 0 0 $\overset{11}{\underset{9}{+1}}$
 SUB TOTAL
 5 0 0 $\overset{CA/AMT}{\underset{=}{TEND}}$
 CH

Printout

NON-TAX		\$2.00	
TAXABLE	T1	\$3.00	
NON-TAX		\$4.00	
TAX-AMT1		\$3.00	
TAX1		\$0.12	
TOTAL		\$9.12	
CASH		\$5.00	Cash amount tendered
CHARGE		\$4.12	Charge sales

5-7 Corrections

Corrections can be made while you are registering the item (before you press a department key), or after it has already been registered into the memory (by pressing a department key).

5-7-1 Before you press a department key

AC C key clears the last item entered.

Example

- Entered 400 for unit price by mistake instead of 100.

4 0 0 **AC C**

Wrong entry Clears the last item entered.

1 0 0 $\overset{11}{\underset{9}{+1}}$

Correct entry Registered department 1

NON-TAX	\$1.00
---------	--------

Operation

Printout

2. Entered unit price first instead of quantity and then pressed .

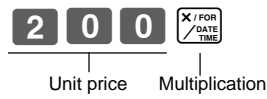

TAXABLE	5 X	@2.00	
	T1		\$10.00



Clears the last item entered.



Quantity Multiplication

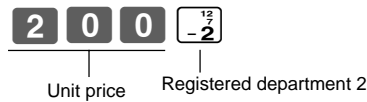

3. Entered 150 for unit price by mistake instead of 105.

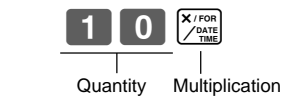

DEPT03	10 X	@1.05	
			\$10.50



Wrong entry Clears the last item entered.



Quantity

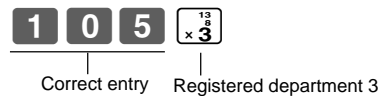

5-7-2 After you pressed a department key

 key cancels the last registered item.

Example

1. Entered unit price 550 by mistake instead of 505 and pressed a department key.



Wrong entry



Cancels the last item registered.



Correct entry

Registered department 1

NON-TAX		\$5.50
ERR CORR		-5.50
NON-TAX		\$5.05

2. Entered unit price 220 by mistake instead of 230 and pressed a department key.

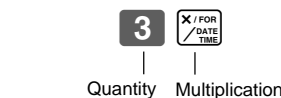

TAXABLE	3 X	@2.20	
ERR CORR	T1		\$6.60
TAXABLE	3 X	@2.30	
	T1		\$6.90



Wrong entry



Cancels the last item registered.



Correct entry

Registered department 2

6. Daily management report

This section tells you the procedures to use to produce reports of the transaction data stored in the cash register's memory.

Important

Remember that when you issue a reset (Z) report, the data that is reported is cleared from the applicable totalizers. To view data without clearing totalizers, issue a read (X) report.

6-1 Financial report

Operation

Printout

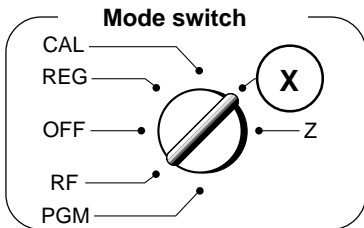

X / FOR
DATE
TIME

X	07-19-2003	14:27		
			0072	
FLASH X				
GROSS TOTAL	QT	67		
NET TOTAL	No	38		
CASH-INDW		\$270.48		
CHARGE-INDW		\$271.24		
CHECK-INDW		\$197.57		
		\$18.19		
		\$45.18		

Mode/Date/Time
Consecutive No.
Report title
Gross sales No. of Items
Gross sales amount
Net sales No. of customers
Net sales amount
Cash total in drawer
Charge total in drawer
Check total in drawer

6-2 Daily/Periodic read/reset report

6-2-1 Daily read/reset report

Mode switch to **X**
(Read)

Mode switch to **Z**
(Reset)

CA / AMT
TEND

CA / AMT
TEND

Z (Reset) report

Z	07-19-2003	19:35		
			0073	
0000	DAILY	Z	0012	
NON-TAX	QT	48		
TAXABLE	QT	28		
DEPT03	QT	\$76.40		
		\$39.23		
DEPT15				

GROSS TOTAL	QT	108		
NET TOTAL	No	46		
CASH-INDW		\$316.80		
CHARGE-INDW		\$325.13		
CHECK-INDW		\$199.91		
TAX-AMT1		\$16.22		
TAX1		\$105.00		
TAX-AMT2		\$105.10		
TAX2		\$4.20		
RF-MODE TTL	No	2		
		\$75.60		
CALCULATOR	No	3		
		\$3.97		

CASH	No	44		
CHARGE	No	3		
CHECK	No	2		
RC		\$105.00		
PD		\$6.00		
-		\$10.00		
%-		\$0.50		
ERR CORR	No	21		
NS	No	12		
		\$0.66		

GRND TTL		\$0000832721.20		

Mode/Date/Time
Consecutive No.
Report code/Title/Reset counter
Dept. name/No. of items
Amount
Gross sales No. of items
Gross sales amount
Net sales No. of customers
Net sales amount
Cash in drawer
Charge in drawer
Check in drawer
Taxable amount 1
Tax amount 1
Taxable amount 2
Tax amount 2
Refund mode count
Refund mode total
CAL mode count
Cash sales count
Cash sales amount
Charge sales count
Charge sales amount
Check sales count
Check sales amount
Received on account total
Payout total
Reduction amount
Premium/Discount amount
Error correct count
No sale count
Non resettable ground total *

* X (Read) report has the same contents except * marked items.

6-2-2 Periodic read/reset report

Mode switch to **X** or **Z**

1 0 CA / AMT
TEND

Z	07-19-2003	19:50		
			0074	
0010	PERIODIC	ZZ	0001	
GROSS TOTAL	QT	67		
NET TOTAL	No	38		
		\$270.73		
		\$271.24		

Mode/Date/Time
Consecutive No.
Report code/Title/Reset counter
Gross sales No. of items
Gross sales amount
Net sales No. of customers
Net sales amount



CONVENIENT OPERATION

1. Various programming

1-1 Unit price for departments

Example

Unit Price	\$1.00	\$2.20	\$11.00
Dept.	1	2	10

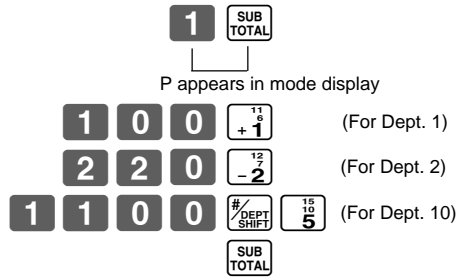

• Unit prices within the range of 0.01~9999.99.

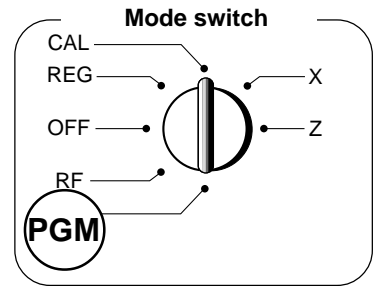

Part-2

1-2 Rate for percent key

Example

Discount Rate	2.5%
---------------	------

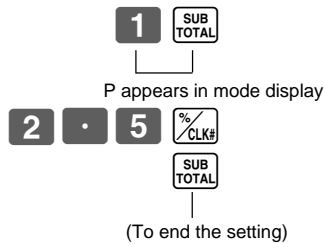

• The rate within the range of 00.01 to 99.99%.

1-3 To change tax status for departments

Tax status for the Departments are fixed as follows:

Department 2: Taxable status 1
Other departments: Nontaxable status.

Example

Status	Nontaxable	Taxable 1
Depts.	1~5, 11	6~10

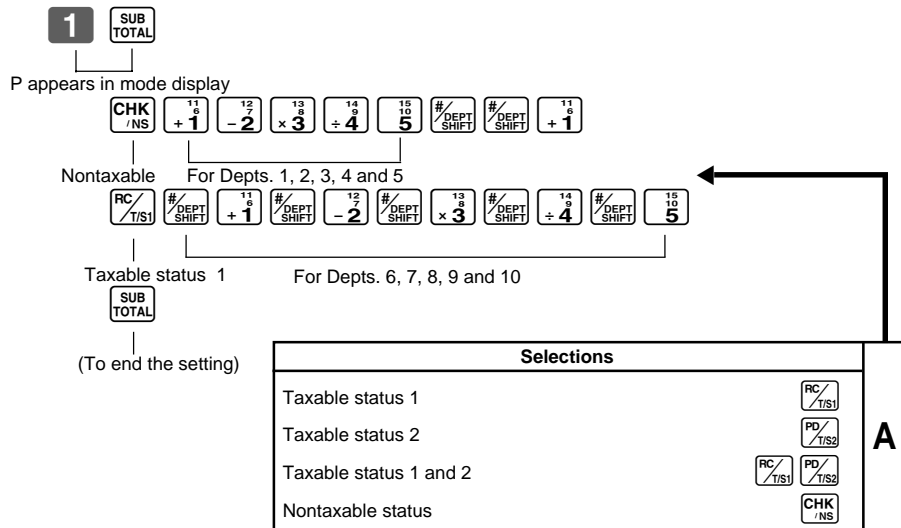

1-4 Status for department

Example

Depts.	Selections		
	A	B	C
1	0	4	1
2	0	5	1

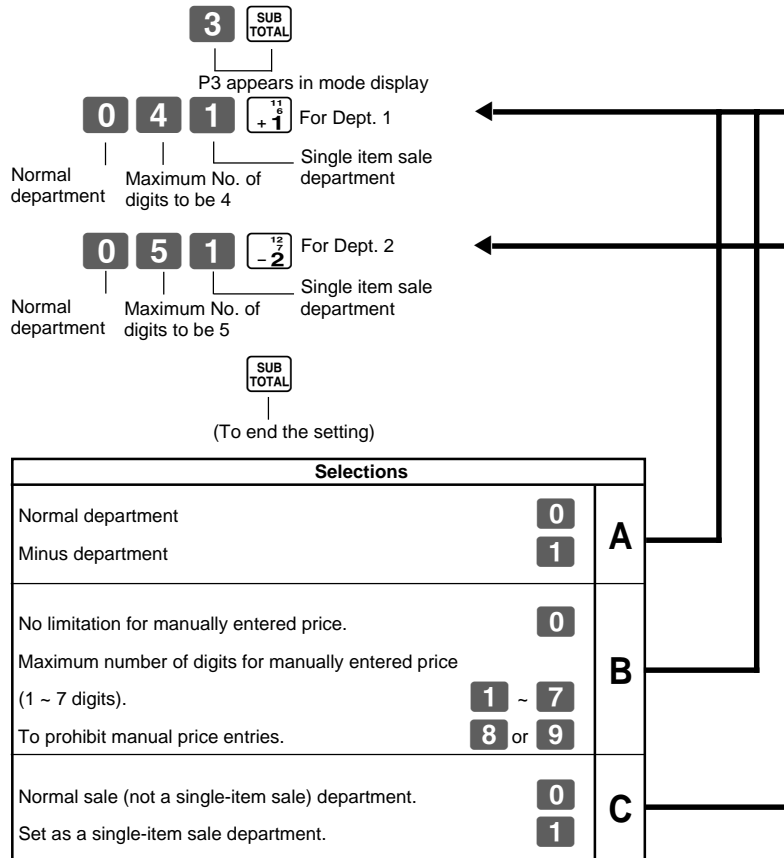

1-5 Status for percent key

1-5-1 To change taxable status for the percent key

Taxable status 1 and 2 are fixed for the percent key.

Example

Change percent key registration as a nontaxable.

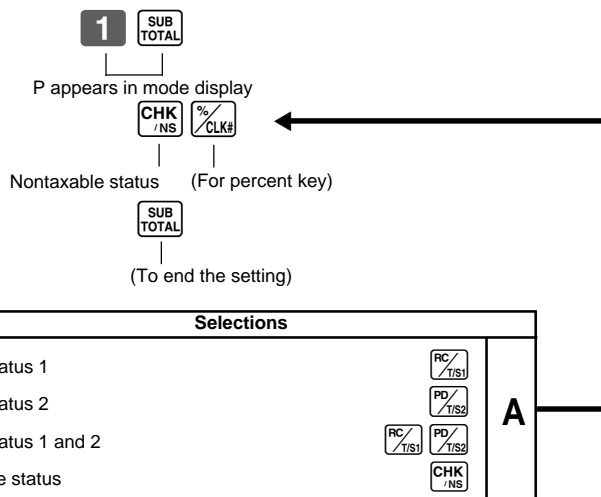

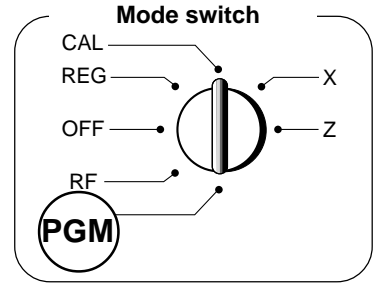

1-5-2 Status for percent key

Example

Round	Up
Percent	%+

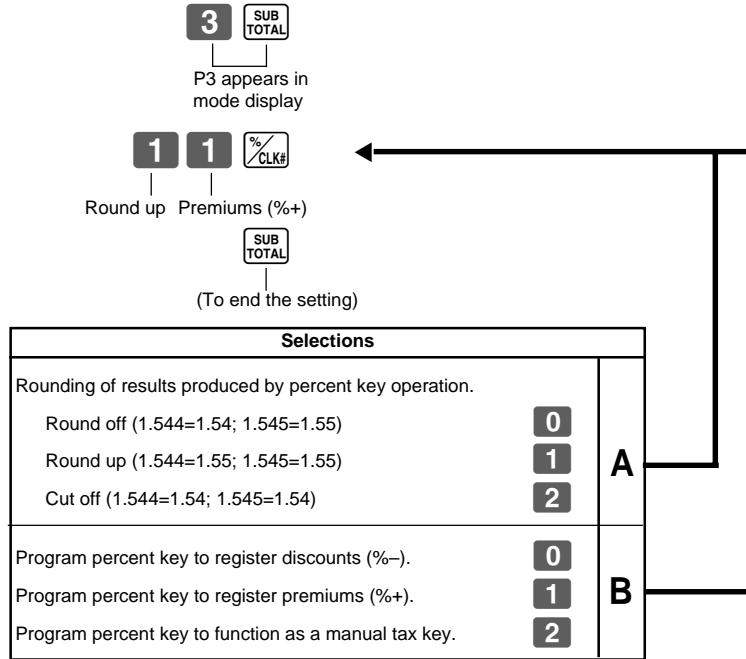

Part-2

1-6 Taxable status for minus key

Example

Change minus key registrations taxable 1 status.

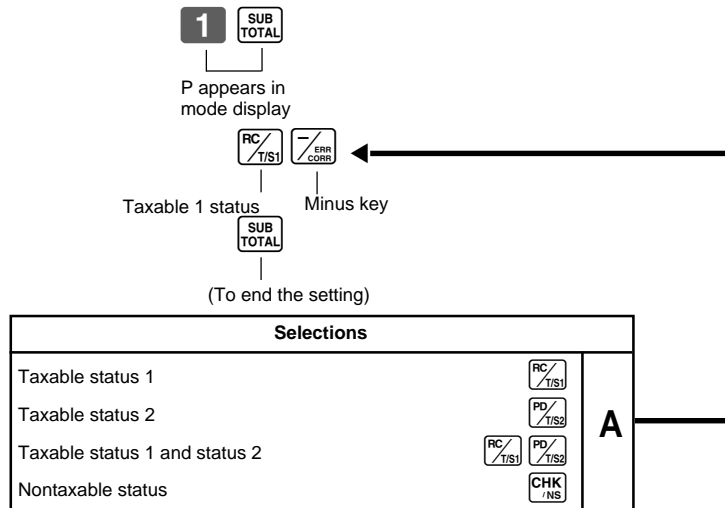

1-7 General features

1-7-1 To set general controls

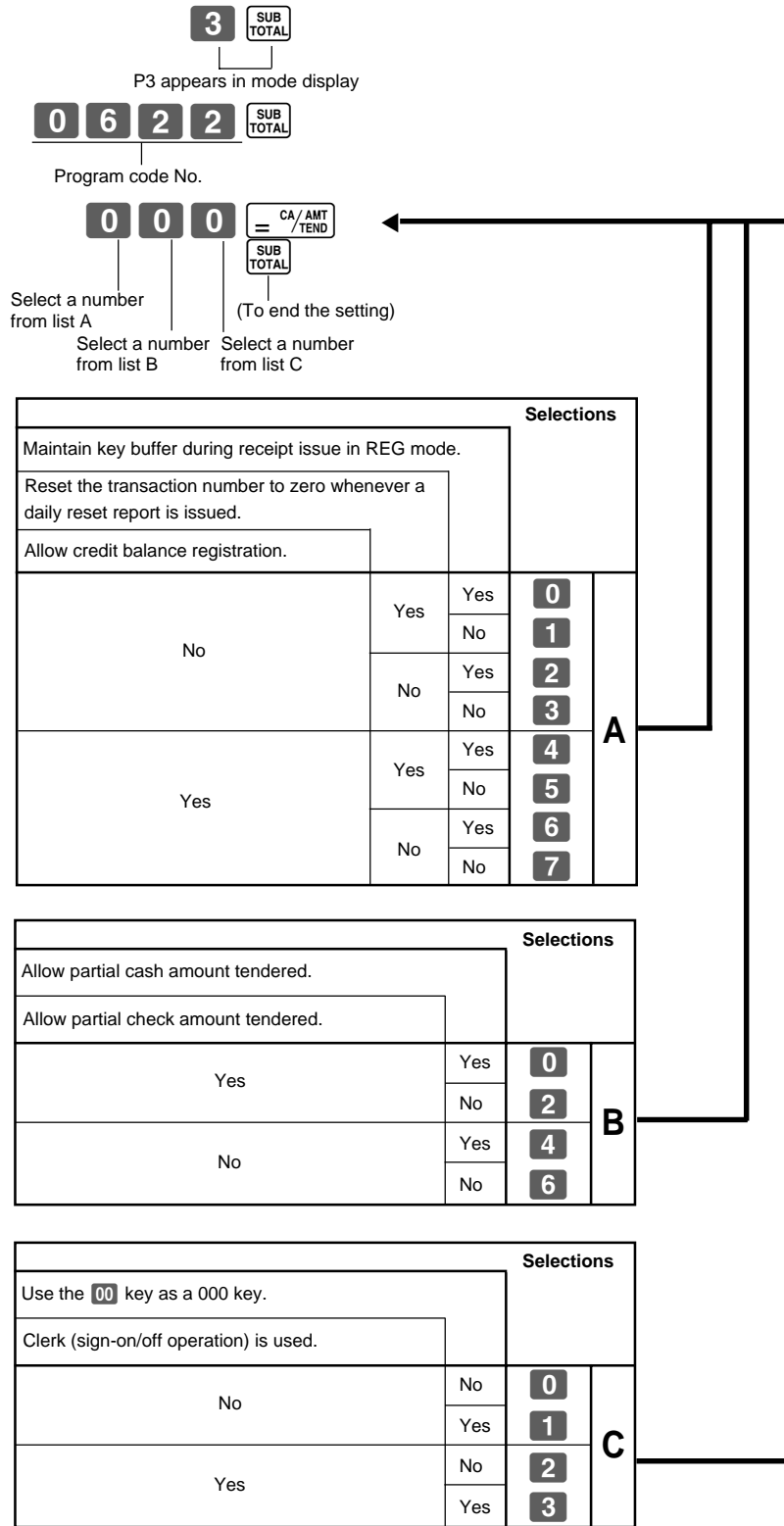

1-7-2 To set printing controls

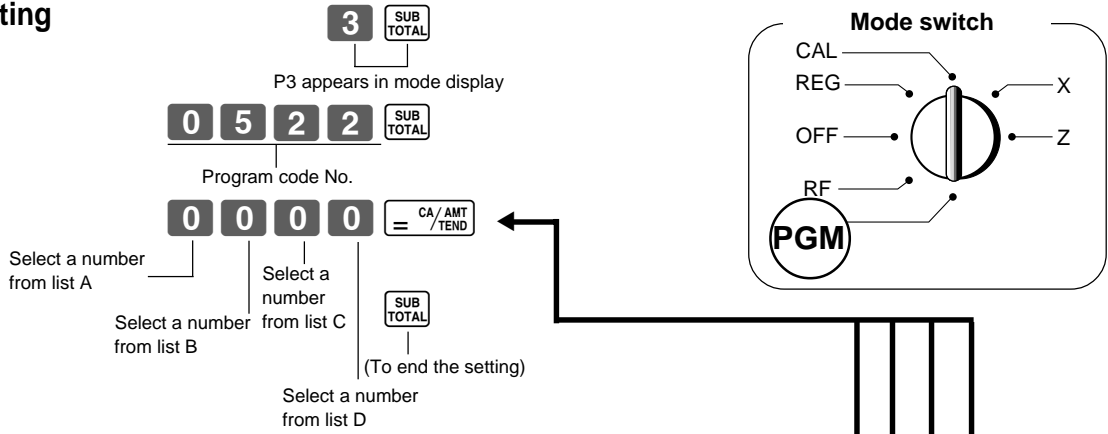

Selections			
Use the printer to print a journal.	0	A	
Use the printer to print receipts.	1		
Selections			
Print zero-total item on the daily/periodic read/reset reports.			
Print receipt by single/double height characters.			
BY SINGLE HEIGHT	Yes	0	B
	No	1	
BY DOUBLE HEIGHT	Yes	2	
	No	3	
Selections			
Print RF mode count/amount on the daily read/reset report.			
Print the grand sales total on the daily reset report.			
Print the time on the receipt and journal.			
Yes	No	Yes	C
		No	
	Yes	Yes	
		No	
No	No	Yes	
		No	
	Yes	Yes	
		No	
Selections			
Print the consecutive number on the receipt/journal.			
Print the subtotal on the receipt/journal when the subtotal key is pressed.			
Skip item print on journal.			
No	No	Yes	D
		No	
	Yes	Yes	
		No	
	Yes	Yes	
		No	

Part-2

1-8 PLU setting

1-8-1 Linkage with departments

Example

PLU No.	1	100
Link Dept. No.	1	10

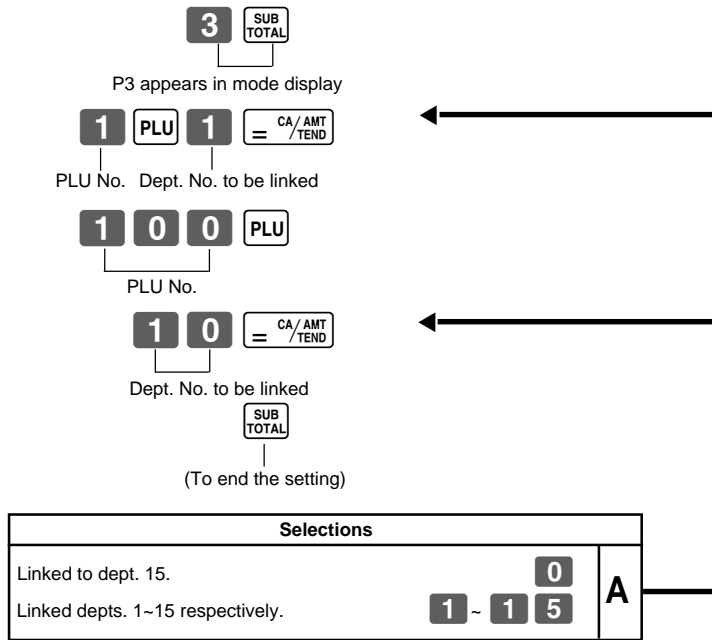

- 100 PLUs can be set.
- When the linked department is not specified, the PLU is linked to department 15.
- Status for a single-item sale and tax status follow the specified linked department.

Note:

DO NOT link to minus department.

1-8-2 Unit prices for PLUs

Example

PLU No.	1	2
Unit Price	\$1.00	\$3.00

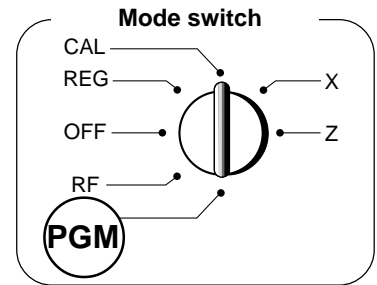
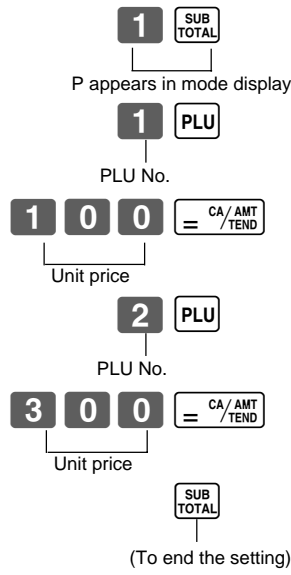

• Unit prices within the range of \$0.01~999.99.

1-9 To control tax status printing

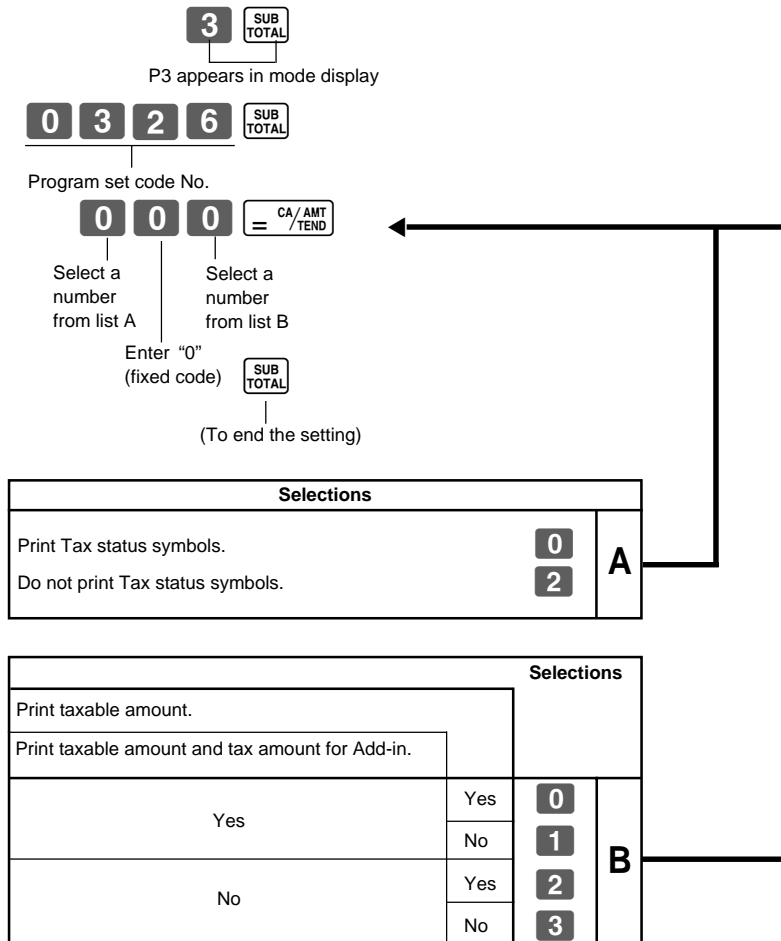

1-10 To program department, PLU, clerk name

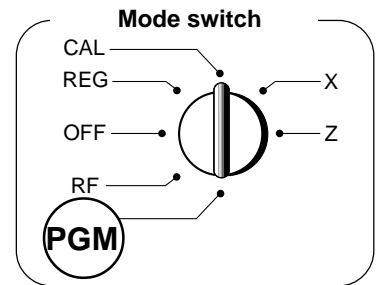

1-10-1 Character keyboard

In the PGM 2 mode, the keyboard becomes character setting keyboard illustrated below after specifying a department, a PLU, or a clerk.

- ① Double size key
Use this key to specify the next character to a double sized character. You must press this key before each double sized character.
- ② Alphabet keys
Use these keys to input characters. Refer to the next page to enter characters.
- ③ Right arrow key
Use this key to input the character located on the same alphabet key. This key is also used for inputting a space.
- ④ Delete key
Use this key to delete character just entered.
- ⑤ PLU key
Use this key to input PLU code.
- ⑥ Department keys
Use this key to specify department.
- ⑦ Department shift key
Use this key to shift department.
- ⑧ Clerk number key
Use this key to input clerk number.

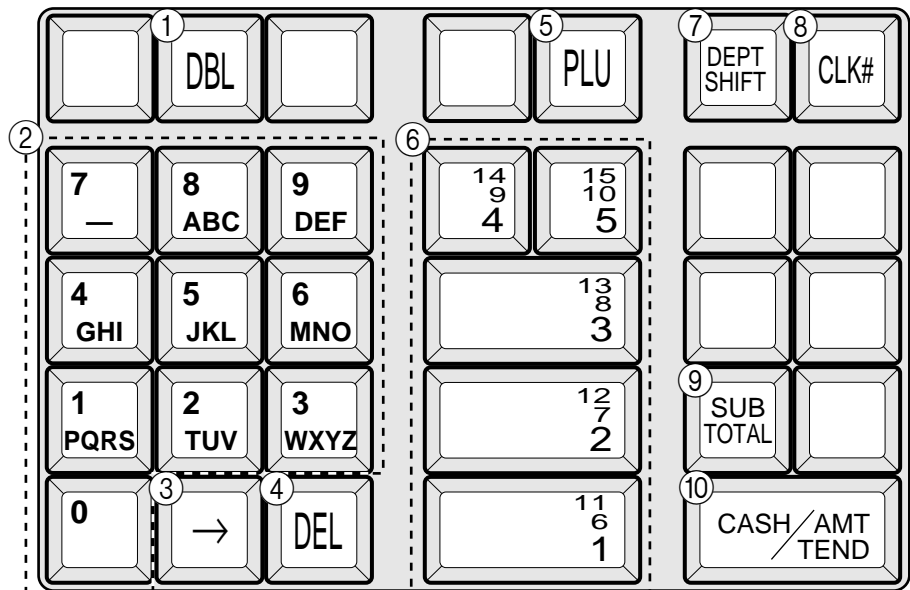

- ⑨ Program end key (SUB TOTAL key)
Use this key to terminate character programming.
- ⑩ Character program key (CA / AMT TEND key)
Use this key to program the PLU / clerk characters just entered before.

1-10-2 Programming department name

Example

Department	1	7
Name	DAIRY	HBA

up to 8 (4 double sized) characters

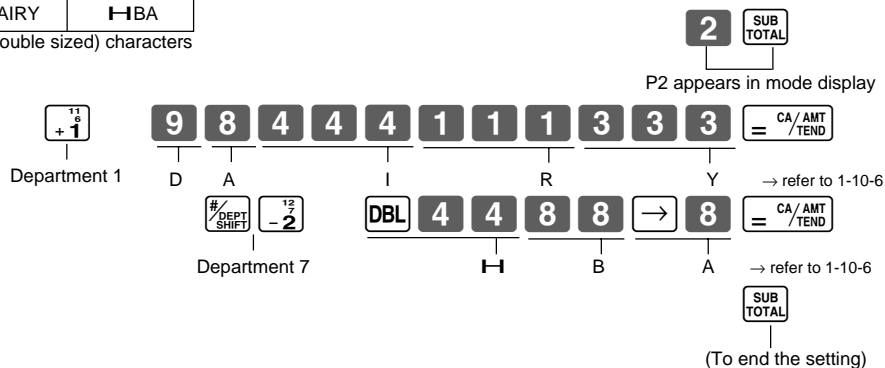

1-10-3 Programming PLU name

Example

PLU (1 ~ 100)	1	50
Name	DAIRY	HBA

up to 8 (4 double sized) characters

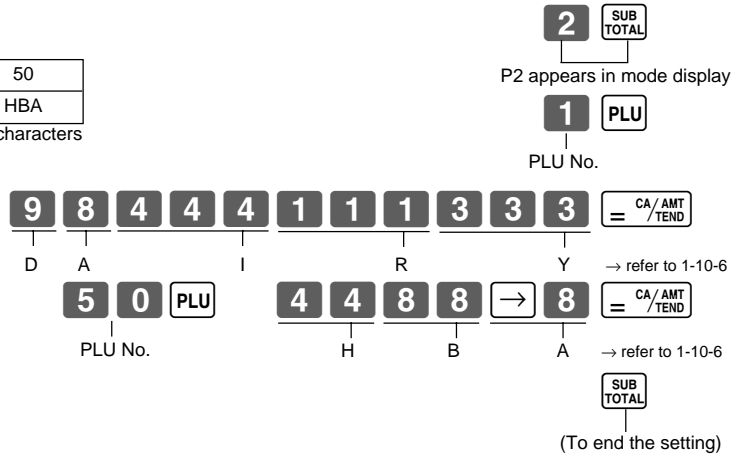

1-10-4 Programming clerk name

Example

Clerk (1 ~ 8)	1	5
Name	JOHN	KATE

up to 8 (4 double sized) characters

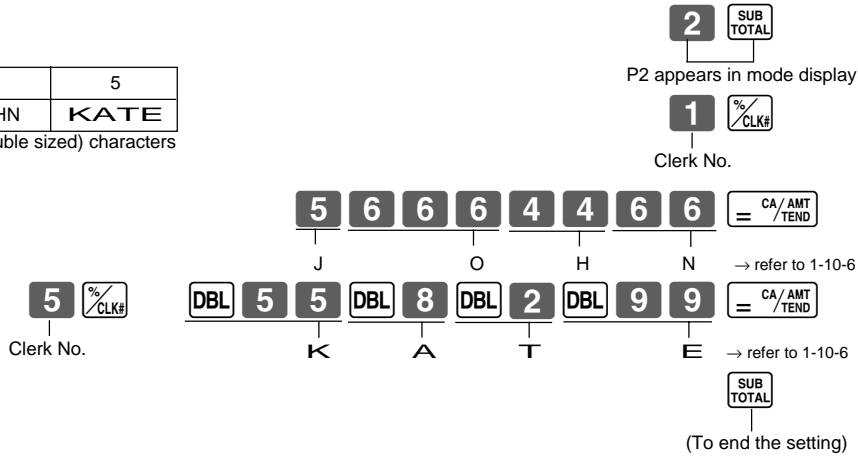

1-10-5 Programming receipt message

Example

Line (1 ~ 5)	2
Message	THANK YOU

up to 24 (12 double sized) characters

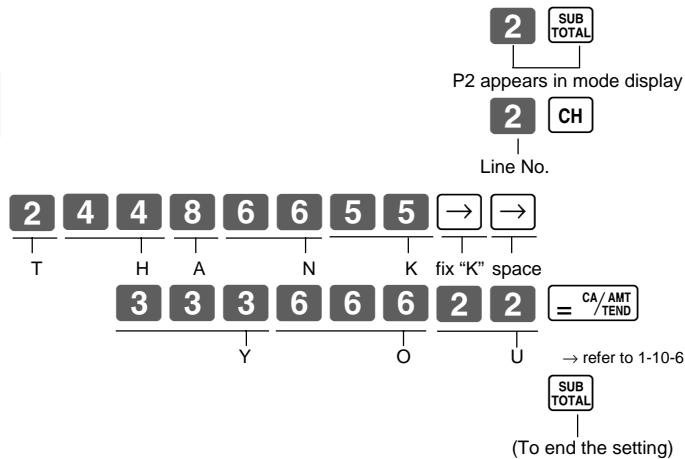

1-10-6 Alphabetical order

Characters are assigned to each numeric key. You can enter "A" by pressing **8** once, "B" twice, "C" three times ...

The following tables indicate character assignment and the depression numbers of the key to enter the appropriate character.

A, B, C, a, b, c, 8, ... 8 key	: A .01 → B .02 → C .03 → a .04 → b .05 → c .06 → 8 .07 →
	→ Ä .08 → Å .09 → Æ .10 → Ǻ .11 → ǻ .12 → Ǽ .13 → Ǿ .14 →
	→ Ç .15 → â .16 → ä .17 → å .18 → ǿ .19 → ø .20 → ǿ .21 →
	→ ã .22 → ç .23 → returns to the beginning
D, E, F, d, e, f, 9, ... 9 key	: D .01 → E .02 → F .03 → d .04 → e .05 → f .06 → 9 .07 →
	→ Ð .08 → É .09 → Ê .10 → Ë .11 → Ë .12 → ð .13 → é .14 →
	→ ê .15 → ë .16 → è .17 → f .18 → returns to the beginning
G, H, I, g, h, i, 4, ... 4 key	: G .01 → H .02 → I .03 → g .04 → h .05 → i .06 → 4 .07 →
	→ Ĝ .08 → Ĥ .09 → Ĭ .10 → Ĵ .11 → İ .12 → ı .13 → ı .14 →
	→ î .15 → ı .16 → returns to the beginning
J, K, L, j, k, l, 5, 5 key	: J .01 → K .02 → L .03 → j .04 → k .05 → l .06 → 5 .07 →
	→ returns to the beginning
M, N, O, m, n, o, 6, ... 6 key	: M .01 → N .02 → O .03 → m .04 → n .05 → o .06 → 6 .07 →
	→ Ñ .08 → Ö .09 → Ø .10 → Ó .11 → Ô .12 → Õ .13 → Ö .14 →
	→ ñ .15 → ô .16 → ö .17 → õ .18 → ø .19 → ó .20 → ö .21 →
	→ returns to the beginning

P, Q, R, S, p, q, r, s, 1, ... 1 key	P .01 → Q .02 → R .03 → S .04 → p .05 → q .06 → r .07 →
	s .08 → 1 .09 → P .10 → p .11 → ⏪ .12 → returns to the beginning
T, U, V, t, u, v, 2, ... 2 key	T .01 → U .02 → V .03 → t .04 → u .05 → v .06 → 2 .07 →
	Ü .08 → ú .09 → Û .10 → ü .11 → Û .12 → û .13 → Û .14 →
	û .15 → µ .16 → returns to the beginning
W, X, Y, Z, w, x, y, z, 3, ... 3 key	W .01 → X .02 → Y .03 → Z .04 → w .05 → x .06 → y .07 →
	z .08 → 3 .09 → ÿ .10 → ÿ .11 → ÿ .12 → returns to the beginning
0 0 key	0 .01 → returns to the beginning
7, Symbols, ... 7 key	? .01 → @ .02 → - .03 → / .04 → : .05 → ! .06 → ? .07 →
	~ .08 → (.09 →) .10 → * .11 → # .12 → + .13 → , .14 →
	^ .15 → ; .16 → < .17 → = .18 → > .19 → \$.20 → ¥ .21 →
	% .22 → & .23 → [.24 →] .25 → ^ .26 → { .27 → .28 →
	} .29 → · .30 → " .31 → ' .32 → \ .33 → _ .34 → ~ .35 →
	£ .36 → × .37 → ¿ .38 → ¡ .39 → € .40 → § .41 → space .42 →
	→ returns to the beginning

Cf.

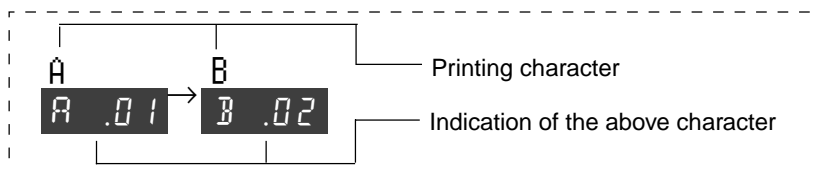

1-11 Printing to read all preset data

1-11-1 Printing preset data except PLU settings

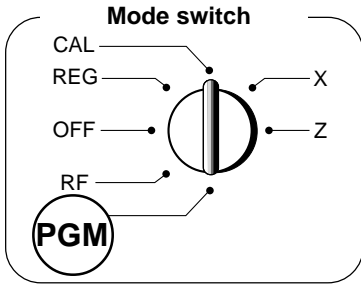

Operation

Printout

CA/AMT/TEND

PGM3			Read Symbol
NON-TAX 000	@1.00		Dept. name/Tax status/Unit price
TAXABLE T1	@10.00		Normal dept./Digit limit/Single item
DEPT15 000	@5.00		
-			Minus/Tax status
% 00	* 12.34%		Percent/Tax status/Rate
0122	12		Fraction/Key attribution
0522	0020		Date, Add mode control (fixed)
0622	0000		Print control
1022	0		General control
0326	002		Calculation control
CLERK 01	01		Tax control
CLERK 02	02		Clerk name/code
CLERK 03	03		
CLERK 06			
CLERK 07			
CLERK 08	08		
0125	0.0000 %		Tax table 1
	0001		
	0001		
	10		
	30		
	54		
	73		
	110		
0225	5.2500 %		Tax table 2
	5002		
	0000		
	01		Receipt message
	02		
YOUR RECEIPT	03		

1-11-2 Printing preset PLU settings

1 CA/AMT/TEND

PGM6			Read symbol
PLU0001 T1	0001		PLU name/Tax status /PLU No.
00	@1.00		Link dept./Unit price
PLU0002 01	@2.00		
PLU0003 01	@3.00		
PLU0004 00	@4.00		
PLU0099 02	@99.00		
PLU0100 00	@10.00		"0" means department 15.

2. Various operations

2-1 Registration using preset price for departments

(Programming: See page 17)

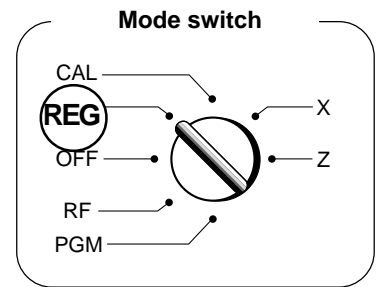

Example

Unit Price	\$1.00	\$2.20	\$11.00
Quantity	1	2	4
Depts.	1	2	3
Amount tendered	\$50.00		

● **Operation** ————— **Printout** ●

11
+ 1

12
- 2

12
- 2

4

X / FOR
DATE
TIME x 3

SUB
TOTAL

5 0 0 0

= CA / AMT
/ TEND

```

NON-TAX          $1.00
TAXABLE T1      $2.20
TAXABLE T1      $2.20
      4 X @11.00
DEPT03          $44.00
TAX-AMT1        $4.40
TAX1            $0.18
TOTAL           $49.58
CASH            $50.00
CHANGE          $0.42
                    
```

Part-2

2-2 Single-Item Sales

(Programming: See page 18)

Example 1

Status	Single item sale
Unit Price	\$0.50
Quantity	1
Dept.	1

5 0

11
+ 1

```

NON-TAX          $0.50
CASH             $0.50
                    
```

— Cash sales

Example 2

Status	Normal	Single item sale
Unit Price	\$1.00	\$0.50
Quantity	1	1
Dept.	2	1

1 0 0

12
- 2

5 0

11
+ 1

SUB
TOTAL

= CA / AMT
/ TEND

```

TAXABLE T1      $1.00
NON-TAX          $0.50
TAX-AMT1        $1.00
TAX1            $0.04
CASH             $1.54
                    
```

— Cash sales

Single-item sale cannot be finalized if an item is registered previously.

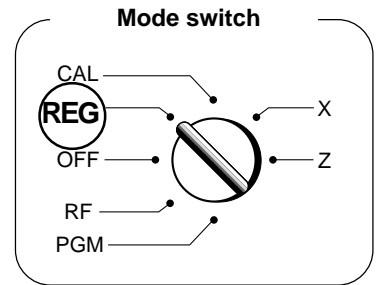

2-3 Check sales

Example

Unit Price	\$35.00
Quantity	2
Dept.	4

Operation **Printout**

3 5 0 0 $\div \overset{14}{9} 4$
 $\div \overset{14}{9} 4$
 SUB
 TOTAL
 CHK
 /NS

DEPT04	\$35.00	
DEPT04	\$35.00	
CHECK	\$70.00	Check sales

2-4 Change the tax status

(Programming: See page 18)

Example

Unit Price	\$1.00	\$2.00
Quantity	1	1
Depts.	1	2
Preset Status	Non-taxable	Taxable 1
This Registration	Taxable 1	Taxable 1

1 0 0 $\div \overset{11}{9} 1$
 $\div \overset{11}{9} 1$
 2 0 0 $\div \overset{12}{7} 2$
 = CA/AMT
 /TEND

NON-TAX	T1	\$1.00
TAXABLE	T1	\$2.00
TAX-AMT1		\$3.00
TAX1		\$0.12
CASH		\$3.12

2-5 Manual tax

Example

Unit Price	\$1.00	\$2.00
Quantity	1	1
Depts.	1	2

1 0 0 $\div \overset{11}{9} 1$
 1 0 $\div \overset{11}{9} 1$
 % / CLK#
 2 0 0 $\div \overset{12}{7} 2$
 = CA/AMT
 /TEND

NON-TAX		\$1.00
TAX		\$0.10
TAXABLE	T1	\$2.00
TAX-AMT1		\$2.00
TAX1		\$0.08
CASH		\$3.08

Manual tax

$\div \overset{11}{9} 1$ key is programmed to function as a manual tax key (see page 20).

2-6 PLU operation

(Programming: See page 22)

Example

PLU No.	1	2
Unit price	\$1.00	\$2.00
Quantity	2	4
Link Dept. No.	1	1
Cash amount tendered	\$10.00	

1 PLU
 PLU
 4 X / FOR
 / DATE
 / TIME
 2 PLU
 = CA/AMT
 /TEND

PLU0001	\$1.00	
PLU0001	\$1.00	Repeat
	4 X	\$2.00
PLU0002	\$8.00	
CASH	\$10.00	

2-7 PLU Single-Item Sale

(Programming: See page 22)

Example

PLU No.	1
Status	Single item sale
Unit Price	\$1.00
Quantity	1

Operation

1

Printout

PLU0001	T1	\$1.00
TAX-AMT1		\$1.00
TAX1		\$0.04
CASH		\$1.04

- For this example, linked department 1 is programmed for a single-item-sale. (Programming: See page 18)
- Single-item sale cannot be finalized if an item is registered previously.

2-8 Split cash/check sales

Example

Unit price	\$30.00	\$25.00
Quantity	1	1
Depts.	2	3
Cash amount tendered		\$20.00
Check		\$36.20

3 0 0 0
 2 5 0 0

 2 0 0 0

TAXABLE	T1	\$30.00
DEPT03		\$25.00
TAX-AMT1		\$30.00
TAX1		\$1.20
TOTAL		\$56.20
CASH		\$20.00
CHARGE		\$36.20

2-9 Post receipt issuance

Example

Unit price	\$1.00	\$2.00
Quantity	1	1
Depts.	1	2
Cash amount tendered		\$5.00

1 0 0
 2 0 0

 5 0 0
 (Receipt is not issued.)

 (Receipt is issued.)

Note:

You can issue only one post receipt per transaction.

(Post receipt)

NON-TAX		\$1.00
TAXABLE	T1	\$2.00
TAX-AMT1		\$2.00
TAX1		\$0.08
TOTAL		\$3.08
CASH		\$5.00
CHANGE		\$1.92

If the transaction contains more than 20 lines (including receipt header), then the total formatted post receipt is issued.

(Total formatted post receipt)

CASH	\$3.08
------	--------

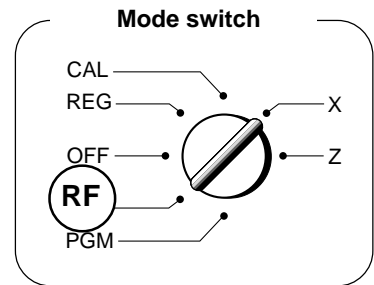

2-10 Refund

Operation

Printout

Example

Unit Price	\$1.00	\$2.00
Quantity	1	1
Dept.	2	3

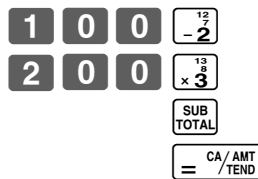

RF	07-19-2003	13:55	
		0040	
TAXABLE	T1	\$1.00	
DEPT03		\$2.00	
TAX-AMT1		\$1.00	
TAX1		\$0.04	
CASH		\$3.04	

Refund mode symbol

After you finish RF mode operation, be sure to return the Mode switch to the REG (register) setting.

2-11 Clerk assignment

(Programming: See page 20)

Clerk assignment system is used to control each clerk sales total. When you select this function on page 20, you can get 8 clerk sales data.

Clerk assignment must be performed prior to starting registration or any other operation, except Program mode.

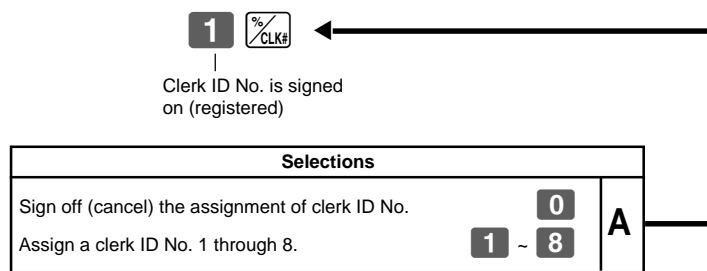
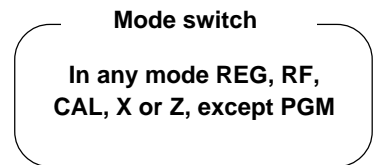

- The assigned clerk name is printed on the receipt or journal for each transaction.
- The assigned clerk memory number is automatically signed off when the mode key is set to OFF position.
- The assigned clerk sales totals with his/her name are printed on the daily X/Z sales report.

NS	No	12
CLERK 01		\$325.13
CLERK 02		\$232.09
GRND TTL		\$0000832721.20

Clerk name/sales total

(Daily X/Z sales report)

Mode switch

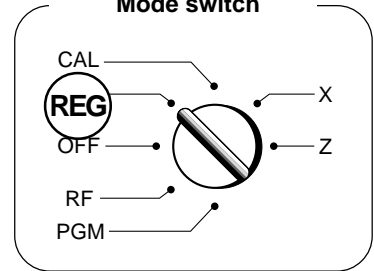

2-12 Other registrations



2-12-1 Reading the time and date

/ FOR DATE TIME
 / FOR DATE TIME
 AC C

13-53
 07-19-03
 0.00

Hour/Minute
Month/Date/Year
• Flashes per second

2-12-2 Paid out from cash in drawer

1 0 0 0 PD / T/S

PD \$10.00 — Paid out amount

2-12-3 Cash received on account

6 0 0 RC / T/S

RC \$6.00 — Received on account amount

2-12-4 Registering identification numbers

5 0 + 1
 1 2 3 4
 5 6 7 8 # / DEPT SHIFT
 = CA / AMT / TEND

NON-TAX \$0.50
 # 12345678
 CASH \$0.50 — Reference No. or ID No.

A reference number or ID number of up to 8 digits can be registered prior to any transaction.

Part-2

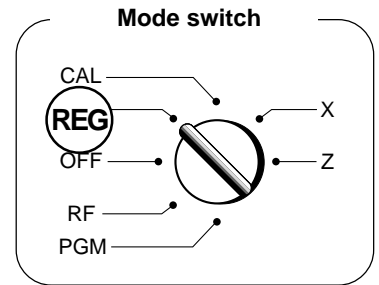

2-12-5 Reduction on subtotal

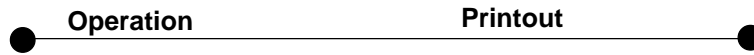

Example
Amount due reduced by \$0.50.

1 0 0 $\frac{12}{-2}$
 2 0 0 $\frac{14}{+4}$
 SUB TOTAL
 5 0 $\frac{ERR}{CRR}$
 = CA / AMT / TEND

TAXABLE	T1	\$1.00
DEPT04		\$2.00
ST		\$3.04
-		-0.50
TAX-AMT1		\$1.00
TAX1		\$0.04
CASH		\$2.54

See page 21 to print the subtotal line.

2-12-6 Premium/Discount

- 2.5% premium/discount (programmed to $\frac{\%}{CLK\#}$ key) applied to first item.
- Be sure to use $\frac{MD}{ST}$ key when you wish to apply a premium/discount to the subtotal. You cannot use the $\frac{SUB}{TOTAL}$ key.
- 7% premium/discount applied to transaction total.
- For programming the $\frac{\%}{CLK\#}$ key as percent minus or percent plus, see page 19.
- For programming percent rate, see page 17.

1 0 0 $\frac{12}{-2}$
 $\frac{\%}{CLK\#}$
 2 0 0 $\frac{12}{-2}$
 3 0 0 $\frac{12}{-2}$
 $\frac{MD}{ST}$
 7 $\frac{\%}{CLK\#}$
 = CA / AMT / TEND

Premium

TAXABLE	T1	\$1.00
2.5%		
%+		\$0.03
TAXABLE	T1	\$2.00
TAXABLE	T1	\$3.00
ST		\$6.03
7%		
%+	T1	\$0.42
TAX-AMT1		\$6.45
TAX1		\$0.26
CASH		\$6.71

Premium rate
 Premium amount
 Subtotal
 Premium rate
 Premium amount

Discount

TAXABLE	T1	\$1.00
2.5%		
%-	T1	-0.03
TAXABLE	T1	\$2.00
TAXABLE	T1	\$3.00
ST		\$5.97
7%		
%-	T1	-0.42
TAX-AMT1		\$5.55
TAX1		\$0.22
CASH		\$5.77

Discount rate
 Discount amount
 Subtotal
 Discount rate
 Discount amount

2-13 PLU report

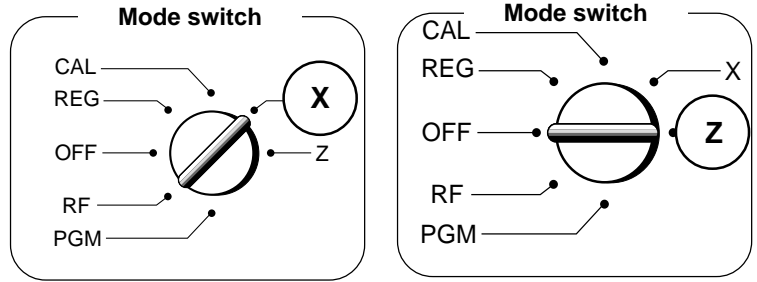

Operation ————— **Printout**

Mode Switch to **X**
(Read)

Mode Switch to **Z**
(Reset)

0 1 = CA/AMT / TEND

```

Z 07-19-2003 19:35
0001 PLU Z 0001
PLU0001 QT 12
          $12.00
PLU0002 QT 27
          $27.00
PLU0100
          $180.00
-----
TOTAL QT 1284
          $10856.89
    
```

Report code/title /Reset counter
PLU name/No. of items
Amount
PLU total count
PLU total amount

Part-2

2-14 About the day-light saving time

It is possible to set the internal clock forward/backward by 1~9 hour(s) for the daylight saving time.

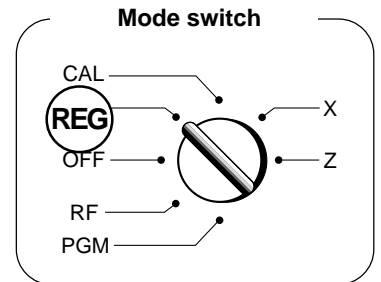

Operation ————— **Display**

• Forward by 1 hour

X / FOR / DATE / TIME

12-34

* **1**

12-34 (blinking)

X / FOR / DATE / TIME

13-34

Set forward by 1 hour.

AC C

0.00

• Backward by 1 hour

X / FOR / DATE / TIME

12-34

12 / 7 / 2

12-34 (blinking)

* **1**

12-34 (blinking)

X / FOR / DATE / TIME

11-34

Set backward by 1 hour.

AC C

0.00

*Put **2** ~ **9**, in case of set the clock by 2~9 hours.

Part 3

CALCULATOR FUNCTION

1. Calculator mode

While registering at REG mode, you can switch to CAL mode and then return to REG mode to resume the registration.

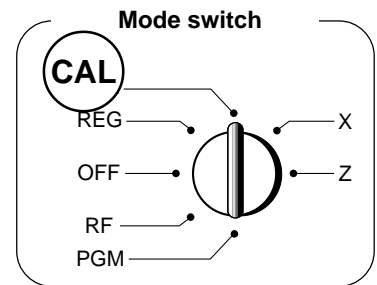

1-1 Calculation examples

<p>Operation</p> <p style="text-align: center;"> AC c 5 +¹¹/₆ 1 AC c (Cancels item entered.) </p> <p> 5 +¹¹/₆ 3 -¹²/₂ 2 = CA/AMT/TEND 2 3 -¹²/₂ 5 6 ×¹³/₈ 7 8 = CA/AMT/TEND 1 5 0 0 ×¹³/₈ 1 2 % CLK# </p>	<p>Display</p> <div style="border: 1px solid black; padding: 5px; text-align: center; width: 100px; margin-bottom: 5px;">[0]</div> <div style="border: 1px solid black; padding: 5px; text-align: center; width: 100px; margin-bottom: 5px;">6.</div> <div style="border: 1px solid black; padding: 5px; text-align: center; width: 100px; margin-bottom: 5px;">-2574</div> <div style="border: 1px solid black; padding: 5px; text-align: center; width: 100px;">180.</div>
--	---

5+3-2=

(23-56)×78=

12% on 1500

1-2 Memory recall

Recalls the current amount onto the display.

- during registration: current subtotal
- registration has been completed: the last amount

On CAL mode

Example
Divide the current subtotal \$30.00 at REG mode by 3 (to divide the bill between 3 persons).

<p>Operation</p> <p style="text-align: center;"> PLU ÷¹³/₄ 3 = CA/AMT/TEND Memory recall </p>	<p>Display</p> <div style="border: 1px solid black; padding: 5px; text-align: center; width: 100px;">10.</div>
---	---

On REG mode

Recalls the current result by pressing PLU key at CAL mode on the display.

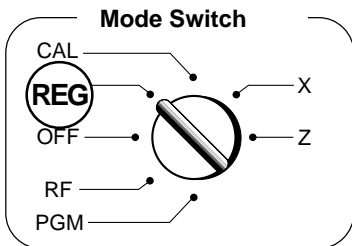

Example
Recall the current result at CAL mode during registration, and register the cash amount due for each person.

<p>Operation</p> <p style="text-align: center;"> PLU = CA/AMT/TEND PLU = CA/AMT/TEND PLU = CA/AMT/TEND Memory recall </p>	<p>Printout</p> <div style="border: 1px solid black; padding: 5px; width: 100%;"> <table style="width: 100%; border-collapse: collapse;"> <tr><td>NON-TAX</td><td style="text-align: right;">\$10.00</td></tr> <tr><td>NON-TAX</td><td style="text-align: right;">\$20.00</td></tr> <tr><td>TOTAL</td><td style="text-align: right;">\$30.00</td></tr> <tr><td>CASH</td><td style="text-align: right;">\$10.00</td></tr> <tr><td>CASH</td><td style="text-align: right;">\$10.00</td></tr> <tr><td>CASH</td><td style="text-align: right;">\$10.00</td></tr> <tr><td>CHANGE</td><td style="text-align: right;">\$0.00</td></tr> </table> </div>	NON-TAX	\$10.00	NON-TAX	\$20.00	TOTAL	\$30.00	CASH	\$10.00	CASH	\$10.00	CASH	\$10.00	CHANGE	\$0.00
NON-TAX	\$10.00														
NON-TAX	\$20.00														
TOTAL	\$30.00														
CASH	\$10.00														
CASH	\$10.00														
CASH	\$10.00														
CHANGE	\$0.00														

1-3 Setting for calculator operation

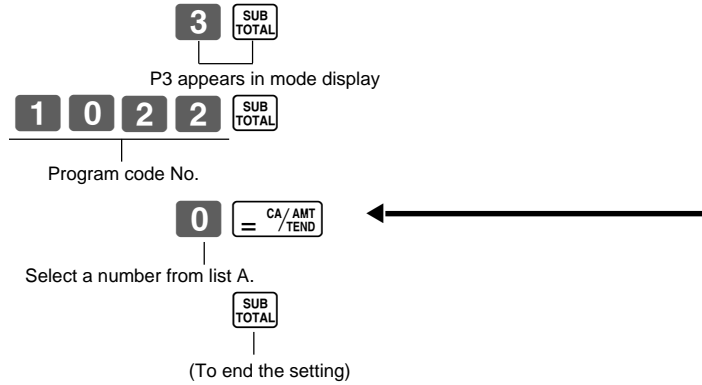
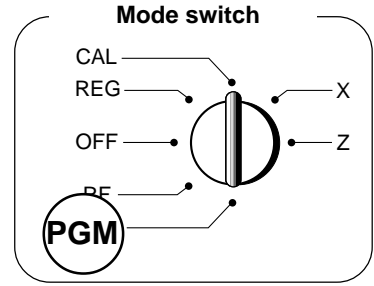

			Selections	
Open drawer whenever <input type="checkbox"/> CA/AMT/TEND is pressed.*				
Open drawer whenever <input type="checkbox"/> CHK is pressed.				
Print No. of Equal key operations on General Control X and Z reports.				
Yes	No	No	0	A
		Yes	1	
	Yes	No	2	
		Yes	3	
No	No	No	4	
		Yes	5	
	Yes	No	6	
		Yes	7	

* Drawer does not open during registration procedures even if you press CA/AMT/TEND by turning the mode switch to CAL position.

Part-3



USEFUL INFORMATION

1. Troubleshooting

	Symptom/Problem	Most common causes	Solutions
1	E01 appears on the display.	Changing modes without completing transaction.	Return key to where it stops buzzing and press .
2	E08 appears on the display.	Sign on operation is not performed.	Prior to starting registration of any other operation, press 1 ~ 8 and then .
3	E10 appears on the display.	Printer is not closed steadily. No paper If there is enough paper installed, open the printer and set the platen arm again.	Close the printer steadily. Replace new paper roll.
4	No date or time on receipt. Paper is not advancing enough.	Printer is programmed as a journal.	Program printer to print receipts.
5	Key won't turn to Z, X, PGM and RF modes.	Using OP key.	Use the PGM key.
6	Drawer opens up after ringing up only one time.	Department is programmed as a single item dept.	Program the dept. as a normal dept.
7	Not clearing totals at end of day after taking report.	Using X mode to take out reports.	Use Z mode to take out reports.
8	Programming is lost whenever register is unplugged or there is a power outage.	Bad or no batteries.	Put in new batteries.
9	Register is inoperative. Can't get money out of drawer.	No power.	Pull lever underneath register at rear.

When the cash drawer does not open!

In case of power failure or the machine is in malfunction, the cash drawer does not open automatically. Even in these cases, you can open the cash drawer by pulling drawer release lever (see below).

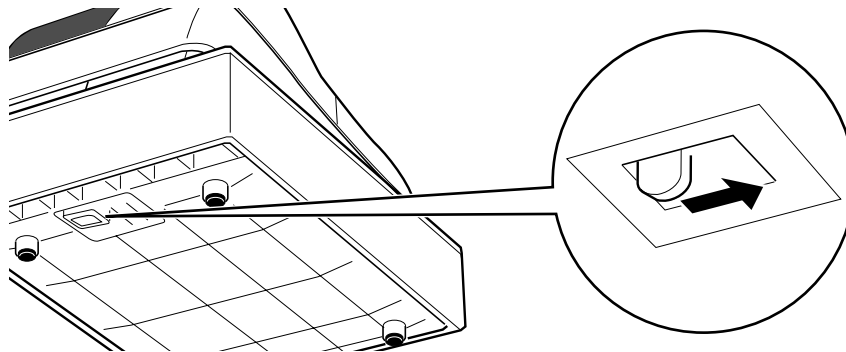

Important!

The drawer will not open, if it is locked with a drawer lock key.

Note: If you cannot resolve your difficulty, please feel free to call your dealer or 1-800-638-9228.

GUIDELINES LAID DOWN BY FCC RULES FOR USE OF THE UNIT IN THE U.S.A. (Not applicable to other areas)

WARNING: This equipment has been tested and found to comply with the limits for a Class A digital device, pursuant to Part 15 of the FCC Rules. These limits are designed to provide reasonable protection against harmful interference when the equipment is operated in a commercial environment. This equipment generates, uses, and can radiate radio frequency energy and, if not installed and used in accordance with the instruction manual, may cause harmful interference to radio communications. Operation of this equipment in a residential area is likely to cause harmful interference in which case the user will be required to correct the interference at his own expense.

FCC WARNING: Changes or modifications not expressly approved by the party responsible for compliance could void the user's authority to operate the equipment.

2. Specifications

Input method:

Entry: 10-key system; Buffer memory 16 keys (2-key roll over)
Display (Digitron): Amount 8 digits (zero suppression); Department/PLU No.; No. of repeats; TOTAL; CHANGE

Printer:

Receipt: 24 digits
(or journal) Automatic paper roll winding (journal)
Paper roll: 58 mm x 80 mm Ø (Max.)

Calculations:

Entry 8 digits; Registration 7 digits; Total 8 digits

Calculator function:

8 digits; Arithmetic calculations; Percent calculations

Memory protection batteries:

The effective service life of the memory protection batteries (3 UM-3, R6P (SUM-3) or LR6 (AM-3) type batteries) is approximately one year from installation into the machine.

Power source/Power consumption:

See the rating plate.

Operating temperature: 32°F to 104°F (0°C to 40°C)

Humidity: 10 to 90%

Dimensions/Weight: 13" (W) x 14 3/16" (D) x 7 3/4" (H) with S drawer
(330 mm (W) x 360 mm (D) x 197 mm (H))
8 lbs 13 oz (4 kg) with S drawer
16 1/8" (W) x 17 3/4" (D) x 9 7/16" (H) with M drawer
(410 mm (W) x 450 mm (D) x 240 mm (H))
19 lbs 13 oz (9 kg) with M drawer

Specifications and design are subject to change without notice.

LIMITED WARRANTY: ELECTRONIC CASH REGISTERS

This product, except the battery, is warranted by Casio to the original purchaser to be free from defects in material and workmanship under normal use for a period, from the date of purchase, of one year for parts and 90 days for labor. For one year, upon proof of purchase, the product will be repaired or replaced (with the same or a similar model) at Casio's option, at a Casio Authorized Service Center without charge for parts. Labor will be provided without charge for 90 days. The terminal resident software and programmable software, if any, included with this product or any programmable software which may be licensed by Casio or one of its authorized dealers, is warranted by Casio to the original licensee for a period of ninety (90) days from the date of license to conform substantially to published specifications and documentation provided it is used with the Casio hardware and software for which it is designed.

For a period of ninety (90) days, upon proof of license, Casio will, at its option, replace defective terminal resident software or programmable software, correct significant program errors, or refund the license fee for such software. Significant program errors will be significant deviations from written documentation or specifications. These are your sole remedies for any breach of warranty. In no event will Casio's liability exceed the license fee, if any, for such software. This warranty will not apply if the product has been misused, abused, or altered.

Without limiting the foregoing, battery leakage, bending of the unit, a broken display tube, and any cracks or breaks in the display will be presumed to have resulted from misuse or abuse. To obtain warranty service you must take or ship the product, freight prepaid, with a copy of the sales receipt or other proof of purchase and the date of purchase, to a Casio Authorized Service Center. Due to the possibility of damage or loss, it is recommended when shipping the product to a Casio Authorized Service Center that you package the product securely and ship it insured. CASIO HEREBY EXPRESSLY DISCLAIMS ALL OTHER WARRANTIES, EXPRESS OR IMPLIED, INCLUDING ANY IMPLIED WARRANTY OF MERCHANTABILITY OR OF FITNESS FOR A PARTICULAR PURPOSE. NO RESPONSIBILITY IS ASSUMED FOR ANY INCIDENTAL OR CONSEQUENTIAL DAMAGES, INCLUDING WITHOUT LIMITATION DAMAGES RESULTING FROM MATHEMATICAL INACCURACY OF THE PRODUCT OR LOSS OF STORED DATA. SOME STATES DO NOT ALLOW THE EXCLUSION OR LIMITATION OF INCIDENTAL OR CONSEQUENTIAL DAMAGES, SO THE ABOVE LIMITATIONS OR EXCLUSIONS MAY NOT APPLY TO YOU. This warranty gives you specific rights, and you may also have other rights which vary from state to state.

CASIO, INC.

570 MOUNT PLEASANT AVENUE,
P. O. BOX 7000, DOVER, NEW JERSEY 07801 U.S.A.

Model: Serial Number: Date of Purchase:

Your Name:

Address:

Dealer's Name:

Address:

CASIO®

CASIO COMPUTER CO., LTD.
6-2, Hon-machi 1-chome
Shibuya-ku, Tokyo 151-8543, Japan

PCR-T275*INC

MO0306-A

Printed on recycled paper.